

Seawright Custom Precast Sill Moldings • SM 02 - 2" to 3"

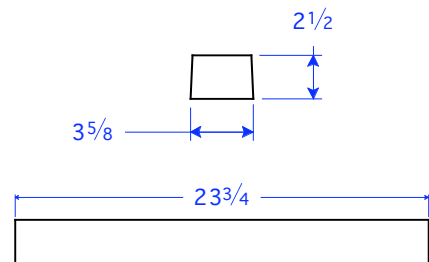
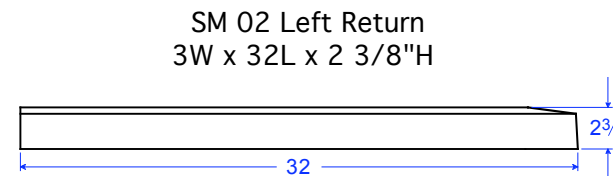
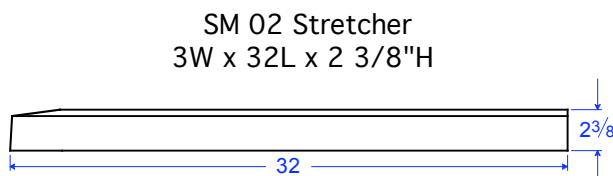
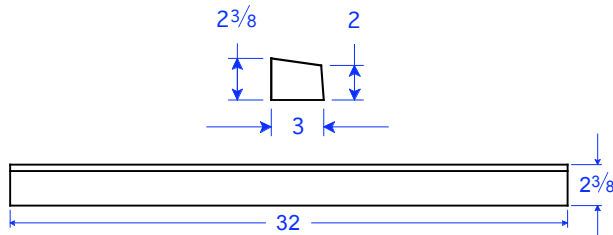
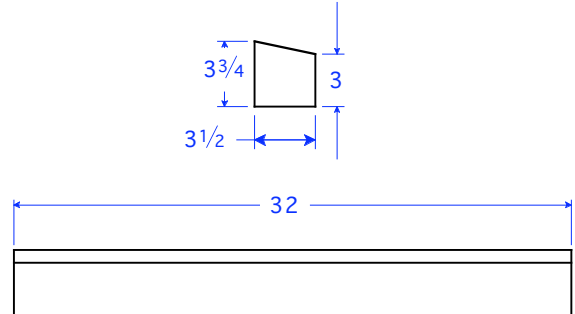
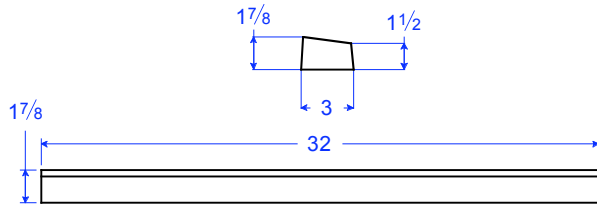
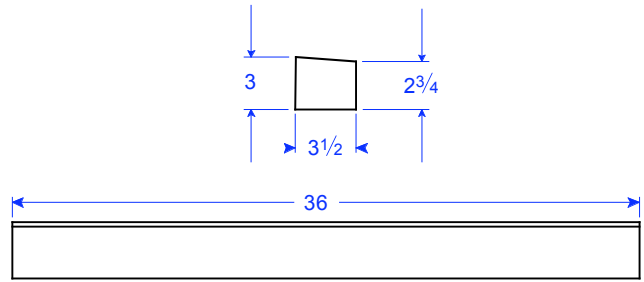
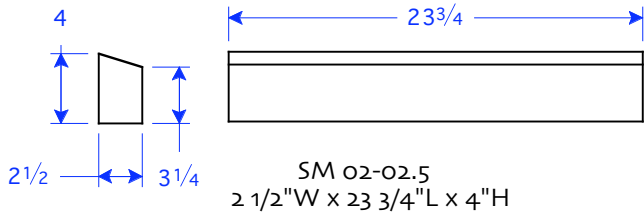

Field Cutting May Be
Required-Pieces To Be
Cut To Fit

09/04/14